

# GFK- Futtermittelsilo MILLENIUM



- ◆ *preiswerte Lagerung für Futtermittel*
- ◆ *Lagerkapazitäten bis 43 m<sup>3</sup> Inhalt pro Silo möglich*
- ◆ *stabile, sichere und robuste Ausführung*
- ◆ *schnelle und einfache Montage*
- ◆ *Fördertechnik, Befüllsysteme, Entleersysteme, Wiegesysteme, Zubehör*



**Weinzierl**  
Lager-  und Fördertechnik GmbH



# Millenium-Serie

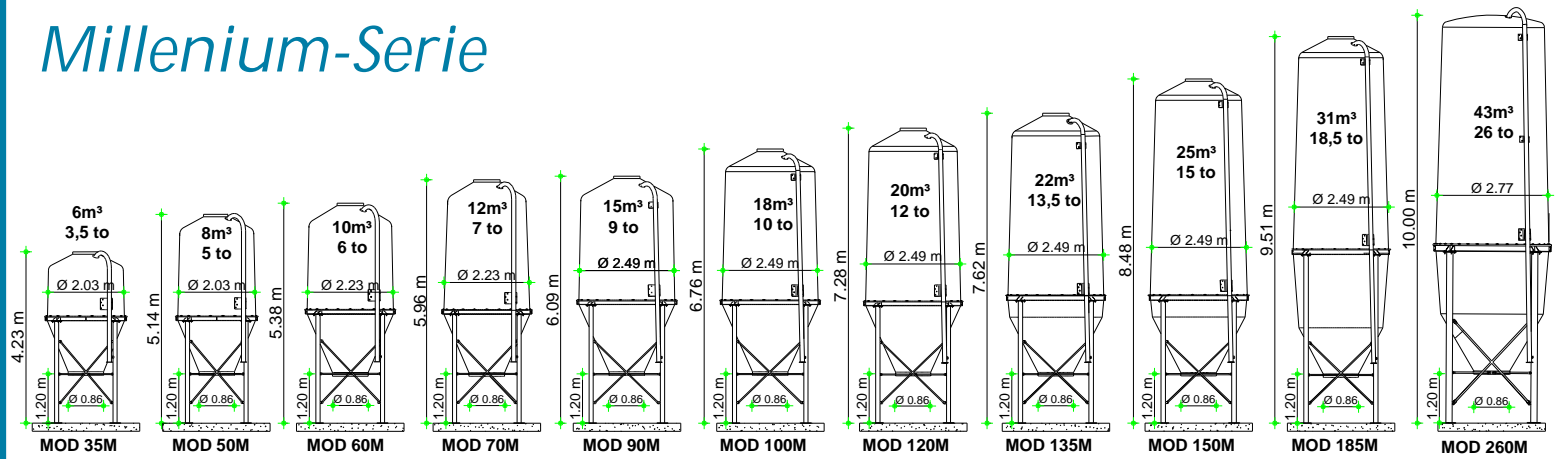

Aufnahmekasten je GFK-Silo erforderlich

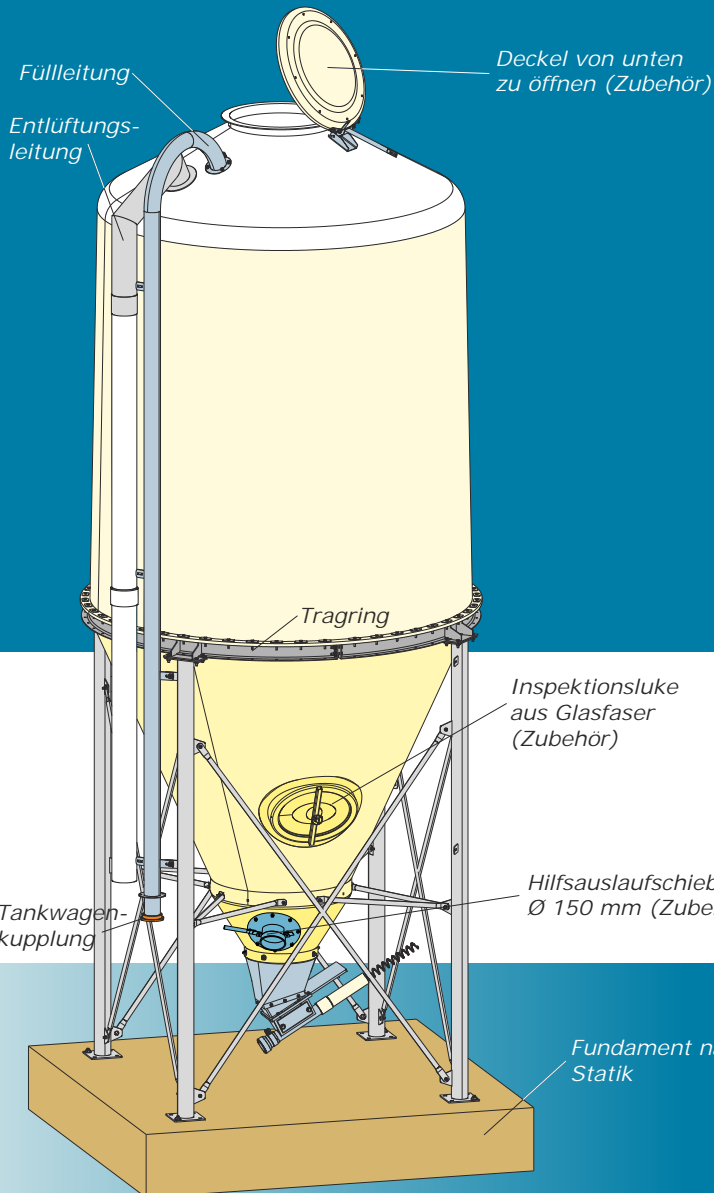

Nr. 1 für Spiralaufnahme

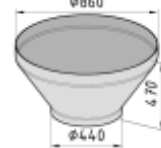

Nr. 2 für Schneckenkasten



Nr. 4 Handschieber

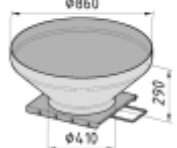

Nr. 8 Handschieber 45°

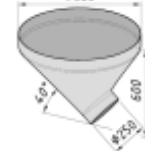

Nr. 9 geschlossener Kasten

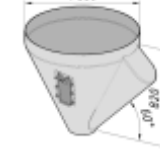

Nr. 10 großer Flansch

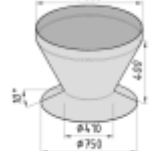

**Weinzierl**

Lager- und Fördertechnik GmbH

Bahnhofstraße 86  
92533 Wernberg  
Tel. +49 (0)96 04 . 93 27 13-0  
Fax +49 (0)96 04 . 93 27 13-10

info@getreidesilo.de  
www.getreidesilo.de